

INSTALL GUIDE

**Covers All 430, 440, 441 and CJ Series
Advanced Security Systems**

REMOTE STARTERS

CAR ALARMS



**ULTRA
START**

www.ultrastarters.com

Technical Support: 866-698-5872 ext 0

support@ultrastarters.com

Note: Some features may not be available on certain models.

FCC/ID Notice

This device complies with Part 15 of the FCC rules. Operation is subject to the following conditions:

- (1) This device may not cause harmful interference, and
- (2) This device must accept any interference received, including interference that may cause undesired operation.

CAUTION: Changes or modifications not expressly approved by the part responsible for compliance void the user's authority to operate this device.

Table of Contents

Table Of Contents	Page 2
Components	
Wiring Diagram (With 10 pin connector)	Page 3
Wiring Diagram (With 11 pin connector)	Page 4
Wiring Description	Pages 5-6
Recommended Installation Procedures	
Basic Installation - Quick start	
Shock Sensor Adjusting	
Test The System	
Programming	Page 7-9
Program Overview	
Quick View Programming	
Program Menu	
System Reset	
Transmitter Programming	Page 10
Car Jack Mode (CJ series Only)	
System Operation	Page 11
Relay Diagrams	Page 12

COMPONENTS

- Three Button Remote transmitter's (430 Series)
- Four Button Remote transmitter's (440 Series)
- Plug-in Valet Switch (Program Switch)
- 10 Pin Main Harness
- 2 pin Keyless Entry harness
- Control Module
- Plug-in Led
- Multi-Tone Siren
- Installation Guide
- Owners Manual

For modules with 10 pin connector only. See page 4 for 11 pin connector.

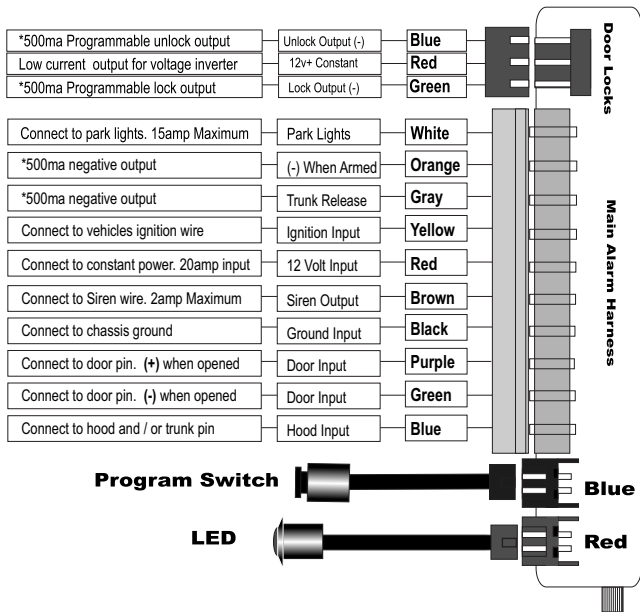

Shock Sensor Adjustment

Increase Sensitivity - Turn the adjustment screw clockwise.

Decrease Sensitivity - Turn the adjustment screw counter clockwise.

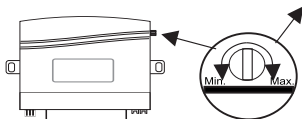

***500ma outputs are low current and are designed to activate relays**

For modules with 11 pin connector only.

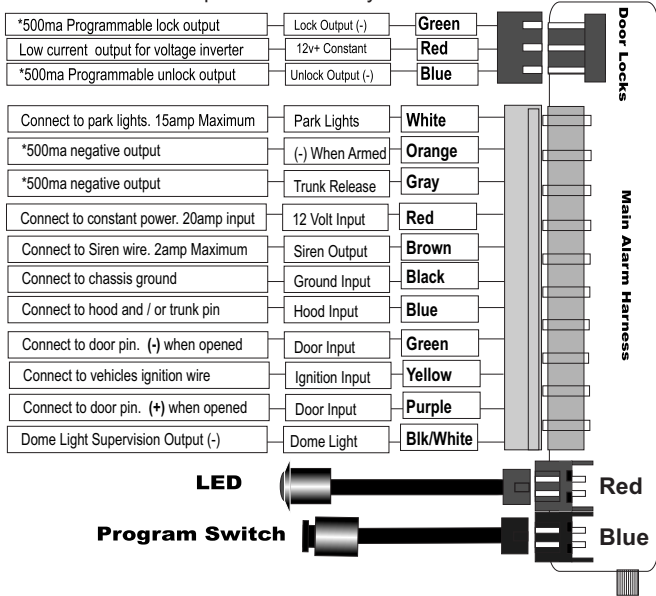

Shock Sensor Adjustment

Increase Sensitivity - Turn the adjustment screw clockwise.

Decrease Sensitivity - Turn the adjustment screw counter clockwise.

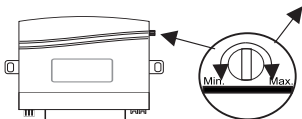

***500ma outputs are low current and are designed to activate relays**

Wiring Descriptions

10 Pin / *11 Pin Connector

White	(+) Park lights	Park light output.
Orange*	(-) When Armed	Negative output when system is armed.
Grey*	(-) Trunk Release	Negative output for trunk release.
Yellow	(+) Ignition Input	Input from vehicles ignition wire.
Red	(+) 12Volt Input	Constant 12 Volt input.
Brown	(+) Siren Output	Positive output for siren.
Black	(-) Ground Input	System ground input.
Purple	(+) Door Input	Positive door pin switch input.
Green	(-) Door Input	Negative door pin switch input.
Blue	(-) Hood Input	Negative input from hood pin switch.
Blk/White*	(-) Dome Supervision	30 second (-) output when disarmed.*

*This wire is only available on models with the 11 pin connector.

3 Pin Connector Red

Green*	(-) Door Lock	Door Lock Output (Programmable)
Red*	(+) 12 Volt Output	12Volt Output for voltage inverter.
Blue*	(-) Door Unlock	Door Unlock Output (Programmable)

*NOTE: 500ma outputs **ONLY!**

Recommended Installation Procedures

Mounting the module- Never mount the module in the engine compartment. Select a location under the dash to install the main module. Be certain that the module is securely attached and does not obstruct any serviceable areas. Mount the module so that it cannot be seen if looking under the dash as it could be easily unplugged by a thief. The module must be free from all moving parts.

Under Hood Connections- Route the hood pin (optional) and Siren wire through the firewall, into the engine compartment. Always try to pull the wires through a factory rubber grommet. If drilling through the firewall, **BE CAREFUL**. Check for obstructions on both sides of the firewall. After drilling use a snap in grommet to protect the wires from sharp edges.

Mounting the Siren- Choose a location in the engine compartment that is away from high heat sources and direct exposure to water. The siren should be mounted as well as grounded to solid metal. Run the wiring for the siren so that it can not be seen or reached from below the vehicle.

Recommended Installation Procedures

Installing the LED- Choose a location that will be highly visible when the LED is installed. Most vehicles are equipped with knock out panels in the dashboard, these panels are easily removable and can be easily replaced if necessary. Once the location is picked, use drill bit and drill a hole through the panel. Test fit the LED into the hole. Plug the Led into the **Red** connector on the main module.

Installing the Program Button- Choose a location to mount the Program Button. This location should be hidden and not visible from outside the vehicle. Once the location of the switch is picked, use a 1/4" drill bit and drill a hole. Remove the nut and push the Program Button through the hole. Replace the nut and tighten until the switch is secure. Plug the Program Button into the **Blue** connector of the main module.

Basic Install

Step 1 - Connect All Of the Following Wires

Black	Ground Input	System ground input.
Yellow	Ignition Input	Input from vehicles ignition wire.
Red	Power Input	Constant 12 Volt input.
Brown	(+) Siren Output	Positive output for siren.
White	(+) Park lights	Positive park light output.
Green*	(-) Door Input	Negative door pin switch input.
Purple*	(+) Door Input	Positive door pin switch input.

*Test for door pin type (+ or -) then connect the appropriate wire.

Step 2- Plug-In The Module

Step 3- Test And Adjust The Shock Sensor (see page 3)

Step 4- Test The System

Your Basic Install Is Complete!

Programming

To Enter Program Mode

- 1) Make sure ignition is in the off position.
- 2) Within three seconds turn the key **ON the OFF**.
- 3) Press and release the Program Button **two times**.
- 4) The siren will chirp and the lights will flash once to confirm.

NOTE: If unit does not enter Program Mode, repeat steps 2-3.

- ** The ignition input wire(yellow on the 10 pin connector) **MUST** be connected.
If it is not connected it will not be possible to enter the Program Mode.

Changing A Programmable Setting

- 1) Enter Program Mode As explained above.
- 2) When in program Mode, change the desired Program Setting by pressing the transmitter buttons in the following sequences.

NOTE: The Systems Default Setting Are Shown In Bold Lettering.



Quick View Programming

Programmable Feature	Press Buttons	One Chirp	Two Chirps
Shock Sensor Disable	#3-#3-#1	Disabled	Enabled
Arm / Disarm Chirps	#2-#1-#1	Chirps Off	Chirps On
Ignition Auto Locks	#1-#3-#2	Off	On
Door Lock Timing	#1-#3-#1	3 Second	.75 Second
Double Pulse Unlock	#2-#2-#1	Two Pulses	Single Pulses
Door Input / Voltage Sense	#1-#1-#3	Voltage	Door Pin
Passive / Active Locks	#3-#3-#2	Active	Passive
Passive / Active Arming	#1-#2-#3	Active	Passive
Car Jack Mode*	#2-#1-#3	Deactivated	Activated
Siren/ Horn Output**	#3-#2-#1	Siren	Horn
System Reset	#3-#3-#3	Confirmed by Three Siren Chirps	

*CJ series ONLY

**441 series ONLY

Enter Program Mode

Entering program mode is done by the following steps:

- 1) Make sure ignition is in the off position.
- 2) Turn the ignition key ON - OFF, leaving **key in the OFF position**.
- 3) Press and release the Valet button two times.
- 4) The siren will chirp one time to confirm entering program mode.
(If this does not happen, turn ignition off, wait five seconds and repeat steps 1-4).

Shock Sensor Disable

- 1 - Enter Program Mode - (Ignition ON-OFF, followed by Valet 2 times)
- 2 - Press & release transmitter buttons in the following sequence:
#3 - #3 then #1
- 3 - The siren will respond with the following:
1 Chirp Shock Sensor OFF
2 Chirps Shock Sensor ON

Arm/ Disarm Chirp

- 1 - Enter Program Mode - (Ignition ON-OFF, followed by Valet 2 times)
- 2 - Press & release transmitter buttons in the following sequence
#2 - #1 then #1
- 3 - The siren will respond with the following:
1 Chirp Chirps Disabled
2 Chirps Chirps Enabled

Ignition Auto Locks

- 1 - Enter Program Mode - (Ignition ON-OFF, followed by Valet 2 times)
- 2 - Press & release transmitter buttons in the following sequence
#1 - #3 then #2.
- 3 - The siren will respond with the following:
1 Chirp Auto Lock Disabled
2 Chirps Auto Lock Enabled

Door Lock Timing

- 1 - Enter Program Mode - (Ignition ON-OFF, followed by Valet 2 times)
- 2 - Press & release transmitter buttons in the following sequence
#1 - #3 then #1
- 3 - The siren will respond with the following:
1 Chirp 3 Second Door Locks
2 Chirps 0.75sec Pulses

Double Pulse Unlock

- 1 - Enter Program Mode - (Ignition ON-OFF, followed by Valet 2 times)
- 2 - Press & release transmitter buttons in the following sequence
#2 - #2 then #1.
- 3 - The siren will respond with the following:
1 Chirp Double Pulse Unlock
2 Chirps Single Pulse Unlock

NOTE: Repeat sequence to change selection

Voltage / Door Pin Sensing

- 1 - Enter Program Mode - (Ignition ON-OFF, followed by Valet 2 times)
- 2 - Press & release transmitter buttons in the following sequence
#1 - #1 then #3
- 3 - The siren will respond with the following:
1 Chirp Voltage Sensing- No Door Pin Connection Needed
2 Chirps Door Pin- Door Pin Connection Required

Passive / Active Locks

- 1 - Enter Program Mode - (Ignition ON-OFF, followed by Valet 2 times)
- 2 - Press & release transmitter buttons in the following sequence
#3 - #3 then #2
- 3 - The siren will respond with the following:
1 Chirp Active Locks
2 Chirps Passive Locks

Passive / Active Arming

- 1 - Enter Program Mode - (Ignition ON-OFF, followed by Valet 2 times)
- 2 - Press & release transmitter buttons in the following sequence
#1 - #2 then #3
- 3 - The siren will respond with the following:
1 Chirp Active Arming
2 Chirps Passive Arming

Car Jack Mode (CJ series ONLY)

- 1 - Enter Program Mode - (Ignition ON-OFF, followed by Valet 2 times)
- 2 - Press & release transmitter buttons in the following sequence
#2-#1 then #3
- 3 - The siren will respond with the following:
1 Chirp Inactive
2 Chirps Active

Siren/ Horn Output (441 series ONLY)

- 1 - Enter Program Mode - (Ignition ON-OFF, followed by Valet 2 times)
- 2 - Press & release transmitter buttons in the following sequence
#3-#2 then #1
- 3 - The siren will respond with the following:
1 Chirp Siren
2 Chirps Horn

Reset System

- 1 - Enter Program Mode - (Ignition ON-OFF, followed by Valet 2 times)
- 2 - Press & release transmitter buttons in the following sequence
#3-#3 then #3
- 3 - The siren will respond with the following:
3 Chirps System Reset

NOTE: Repeat sequence to change selection

Transmitter Programming

Follow the steps below to program the transmitters to the system s memory

Step 1 - Turn the Ignition key **ON then OFF - Leaving Key Off.**

Step 2 - Press and release the Program Button **twice then press and hold.**

Step 3 - The siren will respond with five chirps to confirm Transmitter Program Mode.

Note: If the siren does not respond, repeat Steps1&2

Step 4 - Continue to hold the Program Button and press lock button on each of the transmitter's to be programmed(Maximum of 3 Different transmitter codes).

Step 5 - The system will respond with a siren chirp each time a transmitter is programmed.

Exit - After five seconds the system will exit transmitter program mode automatically.

NOTE: You must program ALL of the transmitters to be used at one time. For the owner's security any transmitters not programmed at this time will be erased from memory.

***** This system will store a maximum of three transmitter codes in memory.**

Car Jack Mode Activation (CJ series ONLY).

- 1) If the ignition key is On and a door is opened the Car Jack Mode Timer will start. The siren will chirp one every second for 10 seconds then trigger into full alarm.
- 2) If the timer was activated by accident, within 10 seconds turn the ignition key back to On then press and release the program button one time. The Car Jack Mode Timer will stop.
- 3) If the timer is not deactivated Car Jack Mode will trigger into full alarm. To deactivate turn the ignition On, then press and release the program button 5 times then press unlock on the remote transmitter.

Emergency Override.

If Car Jack Mode is not deactivated in time, the system will need to be placed into Emergency Override. Turn the ignition key to the On position then press and hold the program button for 20seconds. At this time the customer can bring the vehicle back to the dealer for a system reset.

Alarm Functions

Arm

1. Press and release the  button.
2. The park lights will flash and the siren will chirp one time.
3. The doors will lock (optional).





NOTE: *The LED will start flashing within five seconds. If installed, the starter disable will activate.*

Disarm



1. Press and release the  button on the remote transmitter.
2. The park lights will flash and the siren will chirp two times.
3. The doors will unlock (optional).

NOTE: *The LED will stop flashing. If installed, the starter disable will deactivate.*

Silent Arm/Disarm



1. Press and release the  button then press and release the  button to silent arm. The park lights will flash once to confirm.
2. Press and release the  button then press and release the  button to silent disarm. The park lights will flash twice to confirm.

Panic

1. Press and hold the  button on the remote transmitter.
2. The park lights will flash and the siren will sound.
3. Press and release the  or the  button to deactivate*.

*Panic will be active for 60 seconds or until disabled by the remote transmitter.

Trunk

1. Press and hold the  button for 3 seconds.
2. The doors will unlock (optional), continue holding  until the Trunk Release activates.

Car Finder

1. Press and hold the  button for 3 seconds.
2. The park lights will flash and the siren will chirp 5 times.

Relay Wiring Diagrams

Negative Type Door Locks

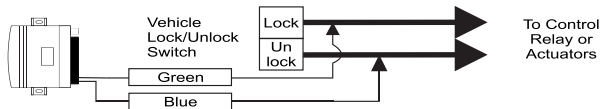

Positive Type Door Locks

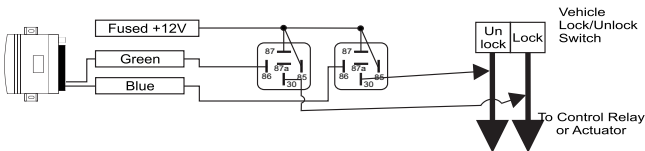

5 Wire / Reverse Polarity Type Door Locks

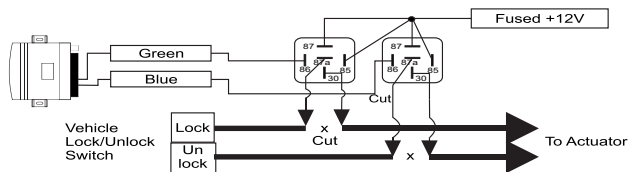

Negative Park Lights- In some cases the park lights may flash erratically after installing the negative park light relay. To correct this issue add a diode between the coil pins of the relay as shown.

